

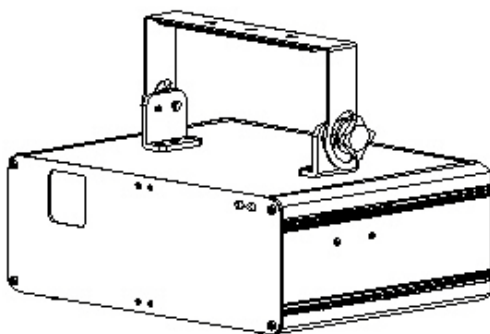

**Stage Line<sup>®</sup>**

## **LSX-1002SRGB | LASER EFFECT UNIT**

**Bestellnummer 38.6700**



**VERSION: V 1.0**

This manual contains important laser system safety and operation information. Read and understand all instructions prior to powering on laser unit the first time, to avoid laser eye injury and to avoid breaking the law. Keep this manual in a safe place for future reference.

## WARNING DATA

**Lasers can be hazardous and have unique safety considerations. Permanent eye injury and blindness is possible if lasers are used incorrectly. Pay close attention to each safety REMARK and WARNING statement in the user manual. Read all instructions carefully BEFORE operating this device.**



**Attention!**

Indicates a skill or other useful information for special situations.



**Important!**

Indicates important information, to protect people from laser incident or damage



**Caution!**

Prevent damage or injury from incorrect operation.



**Laser!**

Laser safety warning labels.



**Recycle**

To protect the environment, recycle packing material wherever possible.



**Indoor**

The projector is for indoor use only, IP20. Use only in dry locations. Keep this device away from rain and moisture, excessive heat, humidity and dust. Do not allow contact with water or any other fluids, or metallic objects.



**Wastebin**

Don't throw this product away just as general trash, please dispose of this product following the abandon electronic product regulation in your country.









**Location**

The projector must be installed in a location with adequate ventilation, at least 50cm (20inches) from adjacent surfaces. Be sure that no ventilation slots are blocked.

## **LASER SAFETY WARNINGS**

Potential laser injury hazard exists with this product! Read these Instructions carefully, which include important information about installation, safe use and service!

-  **Caution** Avoid direct eye contact with laser 了 light. Never intentionally expose your eyes or others to direct laser radiation.
-  **Caution** This laser product can potentially cause instant eye injury or blindness if laser light directly strikes the eyes.
-  **Caution** It is illegal and dangerous to shine this laser into audience areas, where the audience or other personnel could get direct laser beams or bright reflections into their eyes.
-  **Caution** It is a US Federal offense to shine any laser at aircraft.
-  **Caution** There are no user serviceable parts inside the unit. Do not open the housing or attempt any repairs yourself. In the unlikely event your unit may require service, please contact the dealer nearest to you..
-  **Caution** Use of controls or adjustments or performance of procedures other than those specified herein may result in hazardous radiation exposure.

## **NON-INTERLOCKED HOUSING WARNING**

This unit contains high power laser devices internally. Do not open the laser housing, due to potential exposure to unsafe levels of laser radiation. The laser power levels accessible if the unit is opened can cause instant blindness, skin burns and fires.

---

## **LASER SAFETY AND OPERATING INSTRUCTIONS**

---



### **STOP AND READ ALL LASER SAFETY DATA**



Laser light is different from any other light source which you may be familiar. The light from this product can potentially cause eyes injury if not set up and used properly.

Laser light is thousands of times more concentrated than light from any other kind of light source. This concentration of light power can cause instant eye injuries, primarily by burning the retina (the light sensitive portion at the back of the eye). Even if you can not feel “heat” from a laser beam, it can still potentially injure or blind you or your audience. Even very small amounts of laser light are potentially hazardous even at long distances. Laser eye injuries can happen quicker than you can blink.

It is incorrect to think that because these laser entertainment products split the laser into hundreds of beams or laser beam is scanned out in high speed, that an individual laser beam is safe for eye exposure. This laser product uses dozens of milliwatts of laser power (Class 4 levels internally). Many of the individual beams are potentially hazardous to the eyes.

It is also incorrect to assume that because the laser light is moving, it is safe. This is not true. Nor, do the laser beams always move. Since eye injuries can occur instantly, it is critical to prevent the possibility of any direct eye exposure. In the laser safety regulation, it is not legal to aim Class 4 lasers in areas which people can get exposed. This is true even if it is aimed below people’s faces, such as on a dance floor.

- Do not operate laser without first reading and understanding all safety and technical data in this manual.
- Always set up and install all laser effects so that all laser light is at least 3 meters (9.8 feet) above the floor on which people can stand. See “Proper Laser Set-up & Usage” section later in this manual.
- After set up, and prior to public use test laser to ensure proper function. Do not use if any defect is detected. Do not use if laser emits only one or two laser beams rather than dozens/hundreds, as this could indicate damage to the diffraction grating optic, and could allow emission of higher laser levels.

- Do not point lasers at people or animals.
- Never look into the laser aperture or laser beams.
- Do not point lasers in areas in which people can potentially get exposed. such as uncontrolled balconies, etc.
- Do not point lasers at highly reflective surfaces such as windows, mirrors and shiny metal. Even laser reflections can be hazardous
- Never point a laser at aircraft, this is a federal offense.
- Never point un-terminated laser beams into the sky.
- Do not expose the output optic (aperture) to cleaning chemicals.
- Do not use laser if the laser appears to be emitting only one or two beams.
- Do not use laser if housing is damaged or open, or if optics appear damaged in any way.
- Never open the laser housing. The high laser power levels inside of the protective housing can start fires, burn skin and will cause instant eye injury.
- Never leave this device running unattended.
- The operation of a Class 4 laser show laser is only allowed if the show is controlled by a skilled and well-trained operator familiar with the data included in this manual..
- The legal requirements for using laser entertainment products vary from country to country.The user is responsible for the legal requirements at the location/country of use.
- Always use appropriate lighting safety cables when hanging lights and effects overhead.
- For the operation of the laser the “INTERLOCK CONNECTOR” must be connected.

FOR GERMANY: Customers have to use an “EMERGENCY SWITCH” together with the “INTERLOCK CONNECTOR”.

## **LASER EXPOSURE WARNING**

**LASER LIGHT**



**AVOID DIRECT EYE EXPOSURE**

Further guidelines and safety programs for safe use of lasers can be found in the ANSI Z136.1 Standard “For Safe Use of Lasers”, available from “[www.laserinstitute.org](http://www.laserinstitute.org)”. Many local governments, corporations, agencies, military and others, require all lasers to be used under the guidelines of ANSI Z136.1. Laser Display guidance can be obtained via the International Laser Display Association, [www.laserist.org](http://www.laserist.org).

## LASER SAFETY LABEL REPRODUCTIONS

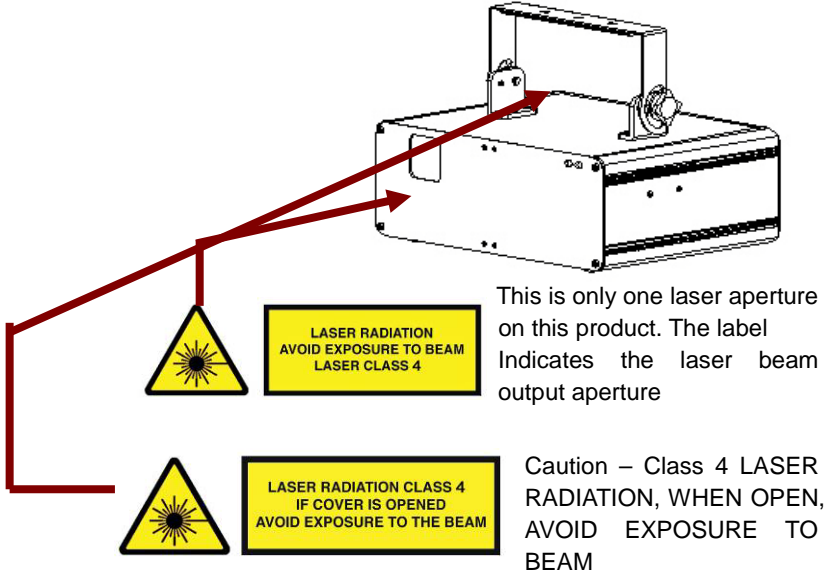

## LASER EMISSION DATA

Laser Classification	Class 4
Red Laser Medium	LD GaAlAs 638nm
Green Laser Medium	DPSS Nd:YVO4, 532nm
Blue Laser Medium	LD GeAs 450nm, typical
Beam Diameter	<5mm at aperture
Pulse Data	All pulses < 4Hz (>0.25sec)
Divergence (each beam)	<2 mrad
Divergence (total light)	<40 degrees
Cooling	TEC & Fan Cooling
Scanning	ILDA Standard: 20Kpps

\* As measured under IEC measurement conditions for classification.

**Note:** The laser diode is exposed to extreme conditions due to the high output power and therefore only has a limited life. Like all wear parts, the laser diode is not subject to any guarantee claims.

## **LASER COMPLIANCE STATEMENT**

This laser product complies with EN/IEC 60825-1 Ed 2,2007-03.

## **GENERAL SAFETY INSTRUCTIONS**

Every person involved with installation and maintenance of this device have to

- Be qualified.
- Follow the instructions of this manual.

**CAUTION! Be careful with your operations. With a high voltage you can suffer a dangerous electric shock when touching the wires!**

This device has left out premises in absolutely perfect condition. In order to maintain this condition and to ensure a safe operation, it is necessary for the user to follow the safety instructions and warning notes written in this manual.



**Important!** The manufacturer will not accept liability for any resulting damages caused by the non-observance of this manual or any unauthorized modification to the device.

- Please consider that damages caused by manual modifications to the device are not subject to warranty.
- Never let the power-cord come into contact with other cables! Handle the power-cord and all connections with the mains with particular caution!
- Make sure that the available voltage is not higher than stated on the rear panel.
- Always plug in the power plug last. Make sure that the power-switch is set to off-position before you connect the device to the mains. The power-plug has to be accessed after installing the device.
- Make sure that the power-cord is never crimped or damaged by sharp edges. Check the device and the power-cord from time to time.

- Always disconnect from the mains, when the device is not in use or before cleaning it. Only handle the power-cord by the plug. Never pull out the plug by tugging the power-cord.
- It is essential to connect the yellow/green conductor to earth.
- The electric connection, repairs and servicing must be carried out by a qualified employee.
- Do not switch the fixture on and off in short intervals as this would reduce the laser diode life.
- For replacement, please use fuses of same type and rating only.
- If the device has been exposed to drastic temperature fluctuation, do not switch it on immediately. The arising condensation water might damage your device. Leave the device switched off until it has reached room temperature..
- Do not shake the device. Avoid brute force when installing or operating the device.
- When choosing the installation-spot, please make sure that the device is not exposed to extreme heat, moisture or dust. There should not be any cables lying around. You endanger your own and the safety of others!
- The minimum distance between the fixture and surrounding walls must be more than 50cm.
- Always fix the fixture with an appropriate safety-rope. Fix the safety-rope at the safety-rope only.
- The ambient temperature must be between 10°C to 40°C.
- Please use the original packaging if the device is to be transported.
- Please consider that unauthorized modifications on the device are forbidden due to safety reasons!

**CAUTION! Operate the device only after having familiarized with its functions. Do not permit operation by persons not qualified for operating the device. Most damages are the result of unprofessional operation**

**CAUTION! If this device will be operated in any way different to the one described in this manual, the product may suffer damages and the warranty void.**



## **BEFORE OPERATION**

### **Unpacking Instructions**

**⚠ CAUTION!** Immediately upon receiving a fixture, carefully unpack the carton, check the contents to ensure that all parts are present, and have been received in good condition. Notify the shipper immediately and retain packing material for inspection if any parts appear damage from shipping or the package itself shows signs of mishandling. Save the package and all packing materials. In the event that a fixture must be returned to the factory, it is important that the fixture be returned in the original factory box and packing.

### **What is included**

The carton or flight case contain following items:

<b>NAME</b>	<b>QTY</b>
Laser Light	1 PCS
KEYs (for key switch)	2PCS
Power Cord	1 PCS
Interlock Connector	1 PCS
USER MANUAL	1 PCS

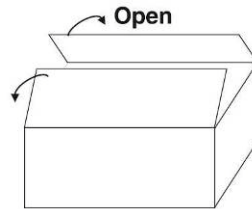

### **Power Supply**

To determine the power requirements for a particular fixture, see the label affixed to the back plate of the fixture or refer to the fixture's specifications chart. A fixture's listed current rating is its average current draw under normal conditions. All fixtures must be powered directly off a switched circuit and cannot be run off a rheostat (variable resistor) or dimmer circuit, even if the rheostat or dimmer

channel is used solely for a 0% to 100% switch. Before applying power to a fixture, check that the source voltage matches the fixture's requirement.

The unit is supplied with a power plug appropriate to its voltage and destination. Should any other connections be required they must be carried out with the following configuration.

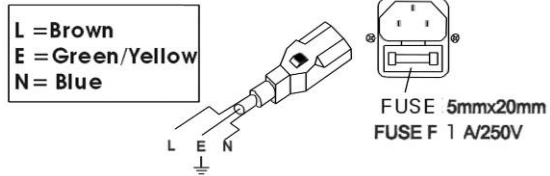

Cable(EU)	Cable(US)	Pin	International
Brown	Black	Live	L
Liht blue	White	Neutral	N
Yellow/Green	Green	Earth	

## DMX-512 connection between fixtures

The fixture is equipped with 2-pin XLR sockets for DMX input and output. The sockets are wired in parallel. Only use a shielded twisted-pair cable designed for 3-pin XLR-plugs and connectors in order to connect the controller with the fixture or one fixture with another.

## Occupation of the XLR-connection

DMX - output  
XLR mounting-sockets (rear view):



DMX-input  
XLR mounting-plugs (rear view):

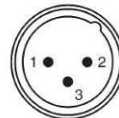

- 1 - Shield
- 2 - Signal (-)
- 3 - Signal (+)



**Caution:** At the laser fixture, the DMX-cable has to terminated with a terminator. Solder a 120 Ohm resistor between Signal (-) and Signal (+) into a 3-pin XLR-plug and plug it in the DMX-output of the last fixture.

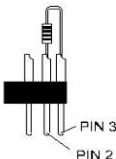

## Polarized adjustment

Any vibration and other reasons of the product during shipping, Laser aggregate light have the possibility to be deviated status. You can adjust through the aggregate three-dimensional adjusting frame carried as below picture:

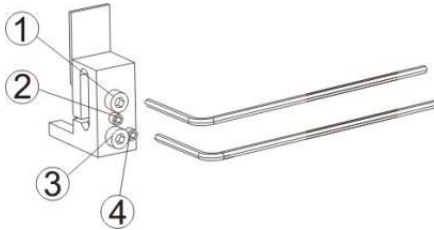

1 and 2 to adjust at the same time  
3 and 4 to adjust at the same time

1 tight 2 loose--light slants to the left  
1 loose 2 close--light slants to the right  
3 tight 4 loose--the light deflection to up  
3 loose 4 close--the light deflection to Down



**Warning!** The polarization adjustment can only be adjusted by qualified professionals, operation, and to ensure strict accordance with the procedures described in this manual.

## Centering adjustment for Multi-effect gobo wheel system

Since transportation, DMX mistake etc, laser image may deviate from the center of lens. You can use the LED digital panel to adjust motor and ensure laser program in the center of lens. Easy operation and practical function.

Pressing the 4 buttons at the same time, turning on the device, entering the model of digital centering. FUNC button choose SHE to set X axis and SHY to Y axis, the “UP” and “DOWN” to set deviation size. Observing the place of image and light lens, moving it to the right centre of light lens, then pressing the “ENTER” to confirm and save.

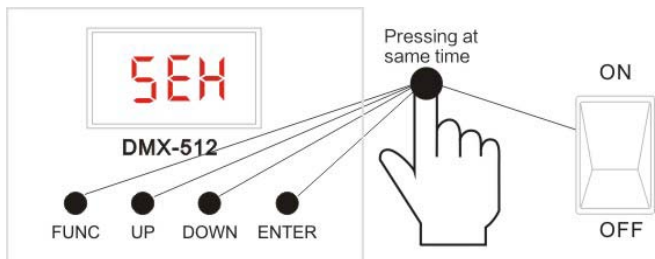

## Building a serial DMX-chain

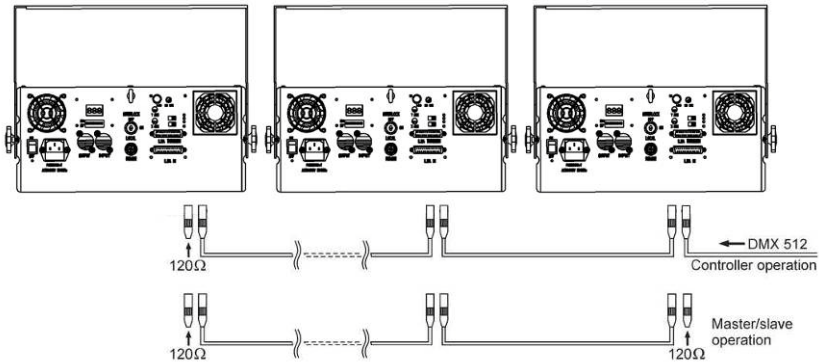

- If you are using the standard DMX-controllers, you can connect the DMX-output of the controller directly with the DMX-input of the first fixture in the DMX-chain. If you wish to connect DMX-controllers with other XLR-outputs, you need to use adapter cables.
- Connect the DMX-output of the first fixture in the DMX-chain with the DMX-input of the next fixture. Always connect output with the input of the next fixture until all fixtures are connected.
- If you use a controller with 5 pins DMX connector, you need to use a 5 to 3 pins adapter
- At last fixture, the DMX cable has to be terminated with a terminator. Solder a 120 Ohm 1/4W resistor between pin 2(DMX-) and pin 3(DMX+) into a 3 pins XLR-plug and plug it in the DMX-output of the last fixture.
- Connect the fixture together in a daisy chain by XLR plug cable from the output of the fixture to the input of the next fixture. The cable cannot be branched or split to a Y cable. DMX 512 is a very high speed signal. Inadequate or damaged cables, soldered joints or corroded connectors can easily distort the signal and shut down the system.
- The DXM output and input connectors are pass-through to maintain the DMX circuit, when power is disconnected to the unit.
- Each fixture needs to have a DMX address to receive the data from the controller. The DMX address number which could be read from rear panel of each fixture is between 000~511.
- The end of the DMX 512 chain should be terminated to reduce signal errors.

### **Proper Laser Set Up & Usage**

This fixture has been designed to be hung. It is recommended for safety purposes, your lighting effect are properly mounted using a suitable hanging clamp and safety cable. Items appropriate for safe and effective mounting are easily sourced from your lighting vendor.

International laser safety regulations require that lasers must be operated in the fashion illustrated below, with a minimum of 3 meters (9.8 ft) of vertical separation between the floor and the lowest laser light vertically. Additionally, 2.5 meters of horizontal separation is required between laser light and audience or other public spaces.

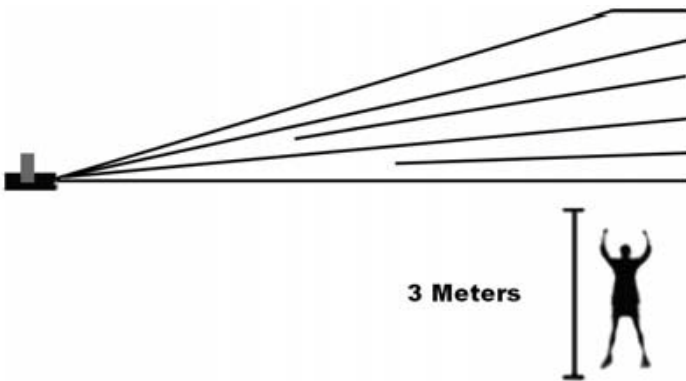

**CAUTION:** Use of controls, adjustments, or performance of procedures other than what is specified herein may result in hazardous radiation exposure

## **Rigging the Fixture**

**CAUTION! Please consider the respective national norms during the installation! The installation must only be carried out by an authorized employee or dealers!**

- The installation of the fixture has to be built and constructed in a way that it can hold 10 times the weight for 1 hour without any harming deformation..
- The installation must always be secured with a secondary safety attachment, e.g. an appropriate catch net. This secondary safety attachment must be constructed in a way that no part of the installation can fall down if the main attachment fails.
- Make sure the area below the installation place is free from unwanted persons during rigging, de-rigging and servicing.
- The operator has to make sure that safety-relating and machine-technical installations are approved by an expert before taking into operation for the first time and after changes before taking into operation another time.
- The operator has to make sure that safety-relating and machine-technical installations are approved by a skilled person once a year.
- The fixture should be installed in the position where persons cannot reach and where persons may walk by or be seated.

**CAUTION! When installing the device, make sure there is no highly inflammable material (decoration articles, etc.) in between a distance of min 0.5 meter.**

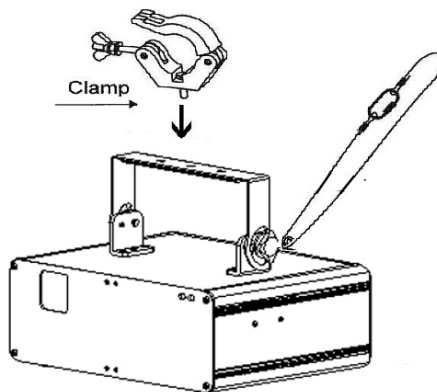

## **PRODUCT OVERVIEW**

- This device has left out premise in absolutely perfect condition. In order to maintain this condition and to ensure safe operation, it is necessary for the user to follow the safety instructions and warning notes written in this manual.
- The manufacturer will not accept liability for any resulting damages caused by the non-observance of this manual or any unauthorized modification to the device.

### **Front Panel**

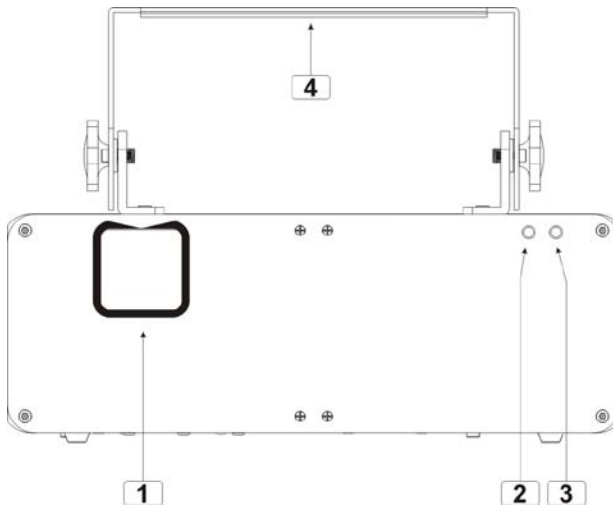

NO	NAME	FUNCTION
1	<b>Laser output</b>	Laser output aperture.
2	<b>POWER</b>	Main power indicated LED. Red is ON.
3	<b>MUSIC</b>	Synchronize to detected music signal
4	<b>HANGING BRACKET</b>	with 2 knobs on both sides to fasten the unit and a mounting hole to fix a mounting hook.

**Rear Panel**

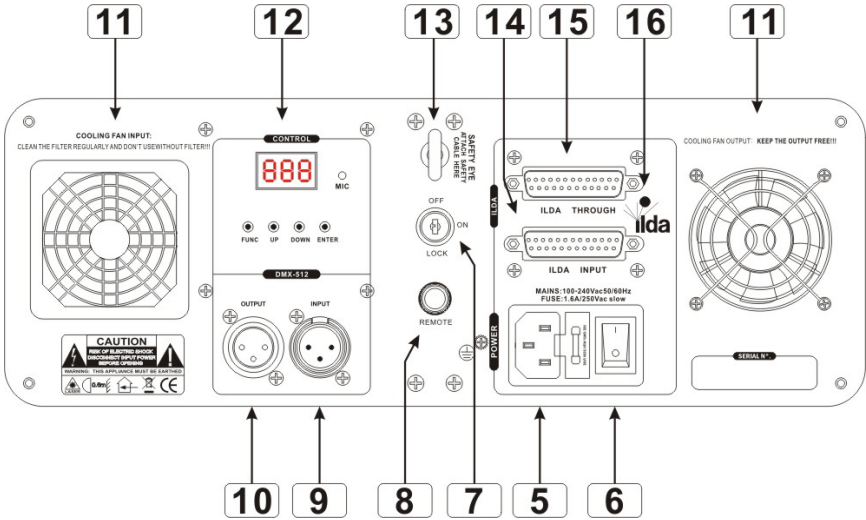

NO	NAME	FUNCTION
5	<b>Mains input</b>	With socket and integrated fuse holder
6	<b>Switch</b>	Switch on and off the power
7	<b>Key switch</b>	Make sure the professional person use
8	<b>Interlock Connector</b>	Switch off the laser manually if error occurs
9	<b>DMX input</b>	3PIN Male XLR port, using for DMX
10	<b>DMX output</b>	3PIN Female XLR port, using for DMX
11	<b>Cooling fan</b>	Cooling and never cover this fan outlet
12	<b>LED control Panel</b>	Intelligent LED control panel of the system
13	<b>Safety eye</b>	Attach the safety cable
14	<b>ILDA INPUT</b>	Standard ILDA DB25 Input
15	<b>ILDA THROUGH</b>	Standard ILDA DB25 Output(through)
16	<b>ILDA</b>	ILDA connection indicator LED. Red is connection.





**IMPORTANT**

**For your own safety and full laser safety Regulation, we do strongly recommend You to take this optional switch!**



## **CONTROL & FUNCTION**

- Regular breaks during operation are essential to maximize the life of this device as it is not designed for continual use.
- Do not switch the unit on and off in short time intervals
- Always unplug the unit when it is not used for a longer time. Or before replacing the bulb or start servicing.
- In the event of serious operation problems, stop using the fixture and contact your dealer immediately.



**Attention Laser Safety Scanner Board is included in the system. The Laser light will be turned off when the scanned angle is less than 1 degree.**

## **Operating Mode**



**Attention Once after every power on laser, the VERSION and MANUFACTURE INFORMATION will be shown in LCD monitor of rear panel.**

When laser is powered on, LCD monitor on rear panel shows the current operating standalone mode or DMX address of DMX mode. With help of LCD control panel, is very easy to set and change the operating mode of laser. After every resetting and saved, the new mode information will be shown on LCD monitor at next power on.



Mode Option, to choose the operating mode of laser.



Confirmation, to confirm the laser to show the present mode at the next operation.



UP/DOWN, to change operating mode, parameter or DMX address.



## OPERATION

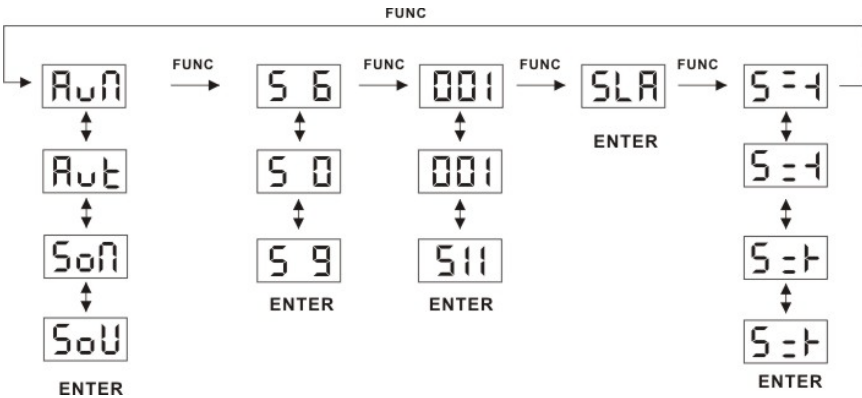

DISPALY	STAND ALONE MODE PREPROGRAM EFFECT
AUN	AUTO show with DGs effect
AUT	AUTO show
SON	SOUND show with DGs effect
SOU	SOUND show



### Attention

In preprogrammed standalone MUSIC SHOW mode, the laser beam will be blank-out in 3 seconds without AUDIO/MIC activated signal.

## DMX MODE

- Press FUNC to enter MODE selection
- Till to LED panel shows 001
- Press ENTER to confirm setting

The laser is working in DMX MODE. With help of UP and DOWN button, the DMX address could be set.

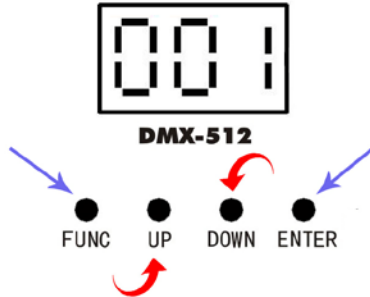

**Attention** In DMX MODE, once the DMX cable is connected with laser and DMX controller, the DMX LED in front panel of laser will be ON.

---

## SLAVE MODE

- Press FUNC to enter MODE selection
- Till to LED panel shows SLA
- Press ENTER to confirm setting

The laser is working in SLAVE MODE. Connect MASTER laser with several SLAVE laser with DMX cable, SLAVE lasers are doing exactly the same laser show as MASTER laser. Please check chapter for DMX cable connection for reference.

## PATTERN MIRROR REVERSE SETTING

- Press FUNC to enter MODE selection
- Till to below LED display is shown in LED panel and the laser will show pattern right side.
- Press ENTER to confirm the setting.

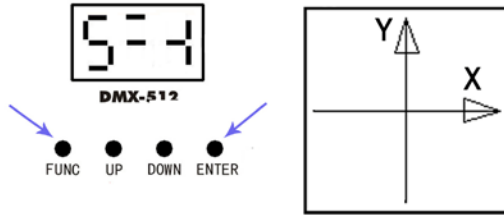

- With help of UP button, the laser scanned world in x direction could be reversed, as the graphic as below.

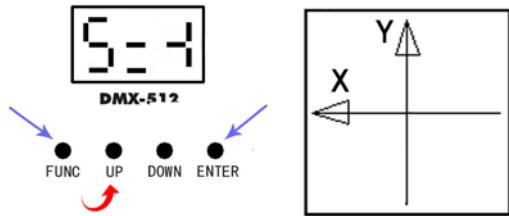

- With help of DOWN button, the laser scanned world in y direction could be reversed, as the graphic as below.

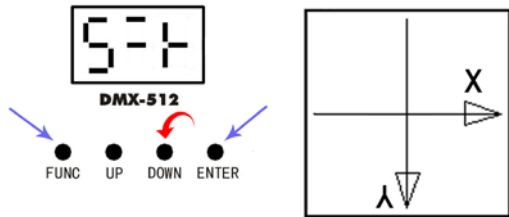

**Attention** Beside of LED programmed mirror reverse setting, the laser scanned world could be set by ILDA control panel.





### ILDA Control Mode











- This unit has the ILDA DB25 port, and it can be controlled by the PC, There is auto transform set in the inside of the unit to transform the ILDA and preprogrammed show. when connecting with the 25 pin cable, the unit will be control by PC, when disconnect the unit, it will be preprogrammed program control.
- In the theory, as long as it is ILDA B25, It can control this unit, but in the reality, some of the software can not control this unit, for the 4 pin and the 17 pin of the output card has not connect. In fact this is an easy problem. As long as you connect them. It can control this unit.



## DMX Channels Chart

Several optional operating modes were preprogrammed set into this laser projector at DMX channel 1. Before control other DMX channels, please be sure that the channel 1 was set in proper mode (value).

### DMX CHANNEL 1 CHART

CHANNEL	VALUE	FUNCTION
<b>CH 1 MODE</b>	000-049	Laser OFF ①
	050-099	AUN, AUTO show with DGs effect
	100-149	AUT, AUTO show
	150-199	SON, SOUND show with DGs effect
	200-249	SOU, SOUND show
	250-255	DMX MODE
<b>CH 2 GROUP</b>	000-051	1 Group Patterns.
	052-103	2 Group Patterns
	104-155	3 Group Patterns
	156-207	4 Group Patterns
	208-255	5 Group Patterns
<b>CH 3 PATTERN</b>	000-255	Every 16 for 1 Group, total 16 patterns.
<b>CH 4 COLOR</b>	000-007	Original 
	008-015	Red 
	016-023	Green 
	024-031	Yellow 

	032-039	Blue	
	040-047	Purple	
	048-055	Light Blue	
	056-063	White	
	064-111	Color Rolling	
	112-159	Color Jumping	
	160-207	Color Moving	
	208-255	Strobing	
<b>CH 5 CLIPPING</b>	000	Full pattern without clipping	
	001-127	0%~99% fixed pattern clipped	
	128-255	Clipping Speed	
<b>CH 6 ZOOMING</b>	000-127	100%~5% fixed pattern zoomed	
	128-169	Zooming IN	
	170-209	Zooming OUT	
	210-255	Alternately Zooming	
<b>CH 7 ZOOM</b>	000-255	Fast to Slow	
<b>CH 8 Y AXIS ROLLING</b>	000-127	0 -359 degree fixed Y axis rolled	
	128-191	Clockwise rolling	
	192-255	Anticlockwise rolling	
<b>CH 9 ROLL PEED</b>	0-255	Fast to Slow	

<b>CH 10 X AXIS ROLLING</b>	000-127	0 -359 degree fixed X axis rolled
	128-191	Clockwise rolling
	192-255	Anticlockwise rolling
<b>CH 11 ROLL</b>	0-255	Fast to Slow 
<b>CH 12 Z AXIS ROLLING</b>	000-127	0 -359 degree fixed Z axis rolled
	128-191	Clockwise rolling
	192-255	Anticlockwise rolling
<b>CH 13 ROLL</b>	0-255	Fast to Slow 
<b>CH 14 X AXIS MOVING</b>	000-127	128 different fixed position on X axis
	128-191	Clockwise moving
	192-255	Anticlockwise moving
<b>CH 15 MOVE</b>	0-255	Fast to Slow 
<b>CH 16 X AXIS MOVING</b>	000-127	128 different fixed position on Y axis
	128-191	Clockwise moving
	192-255	Anticlockwise moving
<b>CH 17 MOVE</b>	0-255	Fast to Slow
<b>CH18 Grating Effect</b>	000-127	Grating Effect OFF
	128-255	Grating Effect ON
<b>CH19 Grating Rotation</b>	000-004	No grating rotating
	005-127	Clockwise grating rotating
	128-133	No grating rotating
	134-255	Anticlockwise grating rotating

**PATTERN LIST**

DMX	1 tunnel	2 pole	3 curve	4 line	5 graphic
000-015					
016-031					
032-047					
048-063					
064-079					
080-095					
096-111					
112-127					
128-143					
144-159					
160-175					
176-191					
192-207					
208-223					
224-239					
240-255					



## SPECIFICTAIONS

<b>Mains Input:</b>	AC100~240V, 50/60Hz
<b>Fuse:</b>	250V /1.6A Slow Blow (20mm Glass)
<b>Total Power:</b>	40W
<b>X/Y Axis Beam Angle:</b>	±20°
<b>Music Control:</b>	Audio / Sound Activated
<b>Laser Power:</b>	200mW 638nm Red 150mW 532nm Green 500mW 450nm Blue
<b>Laser Classification:</b>	Class 4
<b>Laser Safety Standard:</b>	EN60825-1 2007
<b>Condition Temperature:</b>	10~40°C
<b>DMX Connections:</b>	3 pins XLR Male/Female
<b>DMX Channels</b>	Max 19 channels
<b>Measurement:</b>	See picture below
<b>N Weight:</b>	5.9Kg

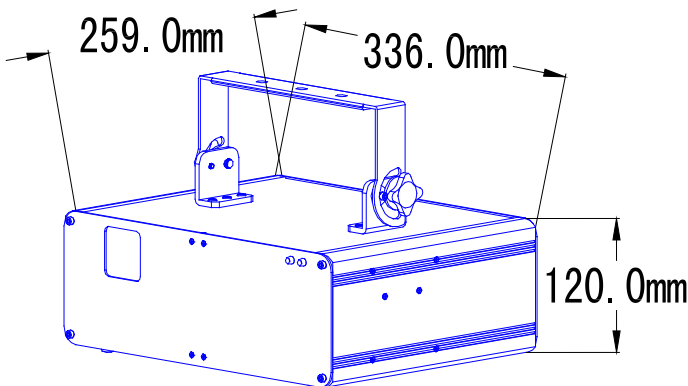

Every information is subject to change without prior notice.

The availability of particular products may vary by region. Please check with the dealer.



MONACOR INTERNATIONAL GmbH & Co. KG • Zum Falsch 36 • 28307 Bremen • Germany  
Copyright © by MONACOR INTERNATIONAL. All rights reserved.



**D A CH**

### Wichtige Sicherheitshinweise

Dieses Gerät ist der Laserklasse 4 zugeordnet.

**WARNUNG** Die zugängliche Laserstrahlung ist sehr gefährlich für das Auge und gefährlich für die Haut. Auch diffus gestreute Strahlung kann gefährlich sein. Die Laserstrahlung kann Brand- und Explosionsgefahr verursachen.



**GB**

### Important Safety Notes

This unit is classified as a class 4 laser product.

**WARNING** The accessible laser radiation is very hazardous to the eye and hazardous to the skin. Diffusely scattered radiation may also be hazardous. The laser radiation represents a fire and explosion hazard.



**F B CH**

### Conseils importants de sécurité

Cet appareil est classé comme produit répondant à la classe laser 4.

**AVERTISSEMENT** Le rayonnement laser accessible est très dangereux pour les yeux et dangereux pour la peau. Un rayonnement même diffusé peut être également dangereux. Le rayonnement laser représente un danger d'incendie et d'explosion.



**I**

### Importanti avvertenze di sicurezza

Questo apparecchio è assegnato alla classe laser 4.

**AVVERTIMENTO** La radiazione accessibile del laser è molto pericolosa per l'occhio e pericolosa per la cute. Anche l'irradiazione diffusa può essere pericolosa. Il raggio laser può provocare incendi ed esplosioni.



**NL B**

### Belangrijke veiligheidsinstructies

Dit apparaat is ingedeeld in de laserklasse 4.

**WAARSCHUWING** De toegankelijke laserstraling is heel gevaarlijk voor het oog en gevaarlijk voor de huid. Ook diffuse straling kan gevaarlijk zijn. De laserstraling kan brand- en explosiegevaar veroorzaken.



- Für den Betrieb eines Lasers der Klasse 4 muss ein Laserschutzbeauftragter vom Unternehmer schriftlich bestellt werden und während des Betriebs anwesend sein (Berufsgenossenschaftliche Vorschrift BGV B2). Laserschutzbeauftragte müssen ausreichende Fachkunde besitzen!
- Für Laser der Klasse 4 ist eine Abnahme erforderlich!

- When using a class 4 laser, the employer has to appoint a laser safety officer in writing who has to be present during operation (BGV B2 = German Accident Prevention & Insurance Association regulation B2). Laser safety officers must have the requisite qualification!
- An approval is required for class 4 lasers!

- Pour le fonctionnement d'un laser de classe 4, un responsable pour la sécurité laser doit être désigné par écrit par l'employeur, il doit être présent pendant le fonctionnement du produit (réglementation allemande de la prévention des accidents et association d'assurances BGV B2). Le responsable de la sécurité laser doit avoir les qualifications requises!
- Pour des lasers de classe 4, une autorisation est nécessaire !

- Per l'impiego di un laser della classe 4, l'imprenditore deve nominare per iscritto un tecnico di sicurezza laser che deve essere presente durante l'uso (norma della Cassa previdenza contro gli infortuni sul lavoro BGV B2). I tecnici di sicurezza laser devono possedere delle conoscenze sufficienti della materia!
- Per i laser della classe 4 è obbligatorio un collaudo!

- Voor het gebruik van laserapparatuur klasse 4 moet er een laser veiligheidsverantwoordelijke schriftelijk worden aangesteld door de onderneming, en moet hij of zij tijdens het bedrijf aanwezig zijn (voorschrift BGV B2 van de Duitse beroepsvereniging). Laser veiligheidsverantwoordelijken moeten over voldoende deskundigheid beschikken!
- Voor laserapparatuur klasse 4 is een keuring vereist!

#### Laserstrahlung

Bestrahlung von Auge oder Haut durch direkte oder Streustrahlung vermeiden

Laser Klasse 4

Nach DIN EN 60825-1:2007

#### Laser Radiation

Avoid eye or skin exposure to direct or scattered radiation

Class 4 laser

According to DIN EN 60825-1:2007

#### Rayonnement laser

Eviter toute exposition des yeux ou de la peau à un rayonnement direct ou diffusé

Laser Classe 4

Selon DIN EN 60825-1:2007

#### Radiazione laser

Evitare l'irradiazione degli occhi o della cute tramite irradiazione diretta o diffusa

Laser classe 4

Secondo DIN EN 60825-1:2007

#### Laserstraling

Rechtstreekse of diffuse straling op ogen en huid moet vermeden worden

Laserklasse 4

Conform DIN EN 60825-1:2007



**E**

### Notas de Seguridad Importantes

Este producto está clasificado como láser de clase 4.

#### ADVERTENCIA



La radiación láser a la que se puede acceder es muy peligrosa para el ojo humano y peligrosa para la piel. La radiación dispersada de forma difusa también puede ser peligrosa. La radiación láser representa un peligro de incendio y de explosión.

- Cuando se utiliza un láser de la clase 4, el dueño tiene que designar por escrito un encargado para la seguridad del láser que deberá estar presente siempre durante el funcionamiento (BGV B2 = Regulación B2 de la Asociación de Aseguradoras y Prevención de Accidentes Alemana). ¡Los encargados de la seguridad láser deben tener la cualificación necesaria!
- ¡Se necesita una autorización para un láser de la clase 4!

**PL**

### Środki bezpieczeństwa

Urządzenie należy do 4 klasy laserów.

#### UWAGA



Wiązka laserowa jest bardzo szkodliwa dla ludzkiego oka, a czasem również skóry. Niebezpieczne może być również odbicie i rozproszone promieniowanie. Promień lasera może spowodować zapalenie się łatwopalnych materiałów.

- Podczas wykorzystywania laserów klasy 4, należy zapoznać się z obowiązującymi dyrektywami (w Niemczech: BGV B2 = German Accident Prevention & Insurance Association regulation B2). Osoby obsługujące urządzenia laserowe muszą posiadać odpowiednie kwalifikacje!
- Stosowanie laserów klasy 4 wymaga zezwolenia!

**DK**

### Vigtige sikkerhedsanvisninger

Denne enhed er klassificeret som en class 4 laser.

#### ADVARSEL



Den tilgængelige laserstråling er yderst skadelig for øjne og hud. Diffus stråling kan også være farlig og skal undgås. Laserstrålingen kan i yderste konsekvens repræsentere brand- og eksplosionsfare.

- Når en class 4 laser benyttes, skal en sikkerhedsansvarlig person skriftligt være udpeget og denne skal altid være tilstede under brugen af laseren. (BGV B2). Den sikkerhedsansvarlige person skal have den nødvendige uddannelse!
- En class 4 laser kræver særlig godkendelse fra myndighederne!

**S**

### Viktig säkerhetsinformation

Denna enhet är klassad som en klass 4 laser produkt.

#### VARNING



Den åtkomliga laserstrålningen är mycket skadlig för ögon och farligt för huden. Diffust spridd strålning kan också vara farligt. Laserstrålning representerar en brand eller explosions risk.

- När du använder en klass 4 laser, ska arbetsgivaren skriftligen utse en tjänsteman för lasersäkerhet som måste vara närvarande under drift (BGV B2 = German Accident Prevention & Insurance Association regulation B2). Laserskyddsombud ska ha erforderlig kompetens!
- Ett godkännande krävs för klass 4 laser!

**FIN**

### Turvallisuudesta

Tuote on luokiteltu 4-luokan laserlaitteeksi.

#### HUOMIO



Lasersäteily on erittäin haitallista silmille ja iholle. Myös hajasäteily voi olla haitallista. Lasersäteily voi aiheuttaa tulipalo- tai räjähdysvaaran.

- 4-luokan laserin turvallisesta käytöstä vastaava henkilö on nimettävä kirjallisesti, ja hänen on oltava paikalla laitetta käytettäessä (vakuutusyhtiöiden vastuuvakuutussäännös BGV B2). Laserin käytöstä vastaavalla henkilöllä on oltava tarvittava pätevyys!
- 4-luokan lasereille vaaditaan hyväksyntä!

#### Radiación Láser

Evite la exposición de los ojos y de la piel con una radiación directa o dispersada

Láser de la clase 4

Según la DIN EN 60825-1:2007

#### Promieniowanie laserowe

Chronić oczy i skórę przed działaniem bezpośrednich oraz odbitych promieni lasera

Klasa lasera: 4

Zgodnie z DIN EN 60825-1:2007

#### Laserstråling

Undgå at øjne og hud udsættes for direkte og indirekte stråling fra laseren

Class 4 laser

DIN EN 60825-1:2007

#### Laserstrålning

Undvik att ögon eller hud utsätts för direkt eller spridd strålning

Klass 4 laser

Enligt DIN EN 60825-1:2007

#### Lasersäteily

Vältä silmien ja ihon altistusta sekä suoralle säteilylle että hajasäteilylle

4-luokan laser

DIN EN 60825-1:2007 mukaan