

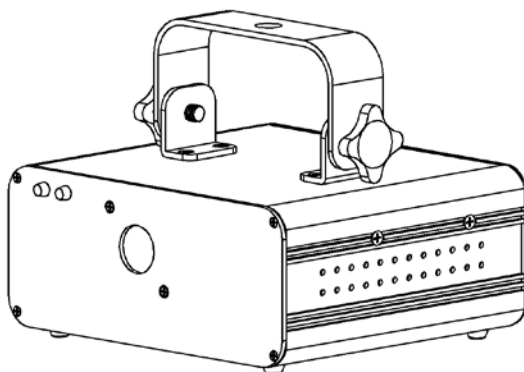

Stage Line[®]

LSX-142SRGY | LASER EFFECT UNIT



VERSION: V 3.0

This manual contains important laser system safety and operation information. Read and understand all instructions prior to powering on laser unit the first time, to avoid laser eye injury and to avoid breaking the law. Keep this manual in a safe place for future reference.

WARNING DATA

Lasers can be hazardous and have unique safety considerations. Permanent eye injury and blindness is possible if lasers are used incorrectly. Pay close attention to each safety REMARK and WARNING statement in the user manual. Read all instructions carefully BEFORE operating this device.



Attention!

Indicates a skill or other useful information for special situations.



Important!

Indicates important information, to protect people from laser incident or damage



Caution!

Prevent damage or injury from incorrect operation.



Laser!

Laser safety warning labels.



Recycle

To protect the environment, recycle packing material wherever possible.



Indoor

The projector is for indoor use only, IP20. Use only in dry locations. Keep this device away from rain and moisture, excessive heat, humidity and dust. Do not allow contact with water or any other fluids, or metallic objects.



Wastebasket

Don't throw this product away just as general trash, please dispose of this product following the abandon electronic product regulation in your country.









Location

The projector must be installed in a location with adequate ventilation, at least 50cm (20inches) from adjacent surfaces. Be sure that no ventilation slots are blocked.

LASER SAFETY WARNINGS

Potential laser injury hazard exists with this product! Read these Instructions carefully, which include important information about installation, safe use and service!

-  **Caution** Avoid direct eye contact with laser 了 light. Never intentionally expose your eyes or others to direct laser radiation.
-  **Caution** This laser product can potentially cause instant eye injury or blindness if laser light directly strikes the eyes.
-  **Caution** It is illegal and dangerous to shine this laser into audience areas, where the audience or other personnel could get direct laser beams or bright reflections into their eyes.
-  **Caution** It is a US Federal offense to shine any laser at aircraft.
-  **Caution** There are no user serviceable parts inside the unit. Do not open the housing or attempt any repairs yourself. In the unlikely event your unit may require service, please contact the dealer nearest to you..
-  **Caution** Use of controls or adjustments or performance of procedures other than those specified herein may result in hazardous radiation exposure.

NON-INTERLOCKED HOUSING WARNING

This unit contains high power laser devices internally. Do not open the laser housing, due to potential exposure to unsafe levels of laser radiation. The laser power levels accessible if the unit is opened can cause instant blindness, skin burns and fires.

LASER SAFETY AND OPERATING INSTRUCTIONS



STOP AND READ ALL LASER SAFETY DATA



Laser light is different from any other light source which you may be familiar. The light from this product can potentially cause eyes injury if not set up and used properly.

Laser light is thousands of times more concentrated than light from any other kind of light source. This concentration of light power can cause instant eye injuries, primarily by burning the retina (the light sensitive portion at the back of the eye). Even if you can not feel “heat” from a laser beam, it can still potentially injure or blind you or your audience. Even very small amounts of laser light are potentially hazardous even at long distances. Laser eye injuries can happen quicker than you can blink.

It is incorrect to think that because these laser entertainment products split the laser into hundreds of beams or laser beam is scanned out in high speed, that an individual laser beam is safe for eye exposure. This laser product uses dozens of milliwatts of laser power (Class 4 levels internally). Many of the individual beams are potentially hazardous to the eyes.

It is also incorrect to assume that because the laser light is moving, it is safe. This is not true. Nor, do the laser beams always move. Since eye injuries can occur instantly, it is critical to prevent the possibility of any direct eye exposure. In the laser safety regulation, it is not legal to aim Class 4 lasers in areas which people can get exposed. This is true even if it is aimed below people’s faces, such as on a dance floor.

- Do not operate laser without first reading and understanding all safety and technical data in this manual.
- Always set up and install all laser effects so that all laser light is at least 3 meters (9.8 feet) above the floor on which people can stand. See “Proper Laser Set-up & Usage” section later in this manual.
- After set up, and prior to public use test laser to ensure proper function. Do not use if any defect is detected. Do not use if laser emits only one or two laser beams rather than dozens/hundreds, as this could indicate damage to the diffraction grating optic, and could allow emission of higher laser levels.

- Do not point lasers at people or animals.
- Never look into the laser aperture or laser beams.
- Do not point lasers in areas in which people can potentially get exposed. such as uncontrolled balconies, etc.
- Do not point lasers at highly reflective surfaces such as windows, mirrors and shiny metal. Even laser reflections can be hazardous
- Never point a laser at aircraft, this is a federal offense.
- Never point un-terminated laser beams into the sky.
- Do not expose the output optic (aperture) to cleaning chemicals.
- Do not use laser if the laser appears to be emitting only one or two beams.
- Do not use laser if housing is damaged or open, or if optics appear damaged in any way.
- Never open the laser housing. The high laser power levels inside of the protective housing can start fires, burn skin and will cause instant eye injury.
- Never leave this device running unattended.
- The operation of a Class 4 laser show laser is only allowed if the show is controlled by a skilled and well-trained operator familiar with the data included in this manual..
- The legal requirements for using laser entertainment products vary from country to country.The user is responsible for the legal requirements at the location/country of use.
- Always use appropriate lighting safety cables when hanging lights and effects overhead.
- For the operation of the laser the "INTERLOCK CONNECTOR" must be connected.

FOR GERMANY: Customers have to use an "EMERGENCY SWITCH" together with the "INTERLOCK CONNECTOR".

LASER EXPOSURE WARNING

LASER LIGHT



AVOID DIRECT EYE EXPOSURE

Further guidelines and safety programs for safe use of lasers can be found in the ANSI Z136.1 Standard "For Safe Use of Lasers", available from "www.laserinstitute.org". Many local governments, corporations, agencies, military and others, require all lasers to be used under the guidelines of ANSI Z136.1. Laser Display guidance can be obtained via the International Laser Display Association, www.laserist.org.

LASER SAFETY LABEL REPRODUCTIONS

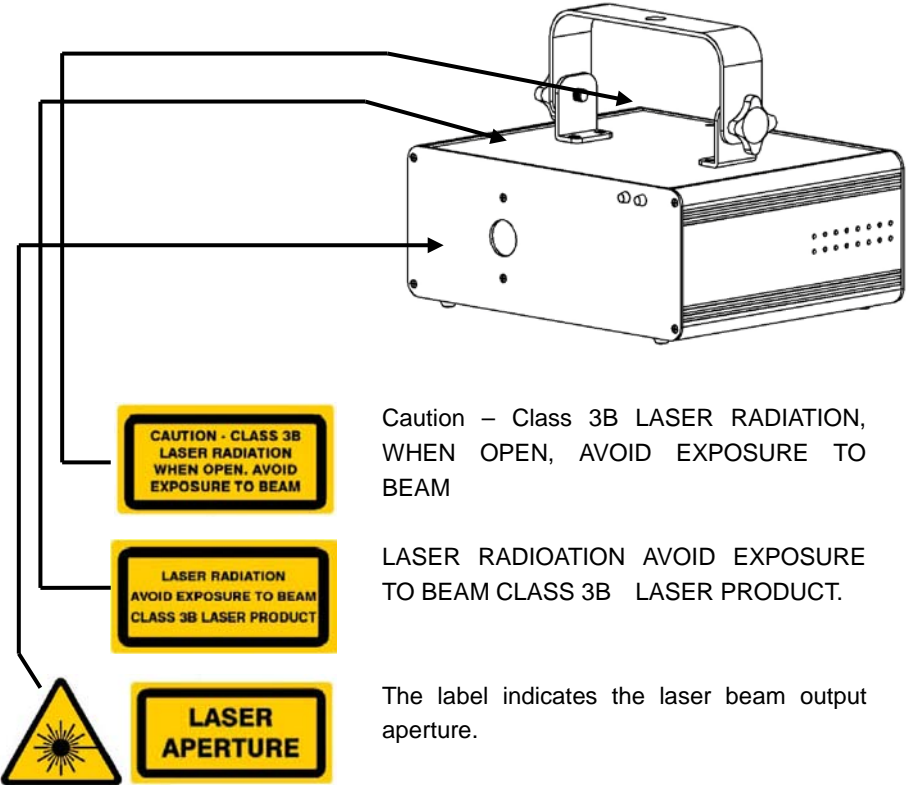

LASER EMISSION DATA

Laser Classification	Class 3B
Green Laser Medium	DPSS Nd:YVO4,532nm
Red Laser Medium	LD GaAlAs 650nm, typical
Beam Diameter	<5mm at aperture
Divergence(each beam)	<12 mrad
Divergence(total light)	<90 degrees
Laser power	R>100mW, G>40mW
Transverse Beam Mode	TEM ₀₀
Cooling	TEC & Fan Cooling
Scanning	ILDA 15Kpps

* As measured under IEC measurement conditions for classification.

Note: The laser diode is exposed to extreme conditions due to the high output power and therefore only has a limited life. Like all wear parts, the laser diode is not subject to any guarantee claims.

LASER COMPLIANCE STATEMENT

This laser product complies with EN/IEC 60825-1 Ed 2,2007-03.

GENERAL SAFETY INSTRUCTIONS

Every person involved with installation and maintenance of this device have to

- Be qualified.
- Follow the instructions of this manual.

CAUTION! Be careful with your operations. With a high voltage you can suffer a dangerous electric shock when touching the wires!

This device has left out premises in absolutely perfect condition. In order to maintain this condition and to ensure a safe operation, it is necessary for the user to follow the safety instructions and warning notes written in this manual.



Important! The manufacturer will not accept liability for any resulting damages caused by the non-observance of this manual or any unauthorized modification to the device.

- Please consider that damages caused by manual modifications to the device are not subject to warranty.
- Never let the power-cord come into contact with other cables! Handle the power-cord and all connections with the mains with particular caution!
- Make sure that the available voltage is not higher than stated on the rear panel.
- Always plug in the power plug last. Make sure that the power-switch is set to off-position before you connect the device to the mains. The power-plug has to be accessed after installing the device.
- Make sure that the power-cord is never crimped or damaged by sharp edges. Check the device and the power-cord from time to time.

- Always disconnect from the mains, when the device is not in use or before cleaning it. Only handle the power-cord by the plug. Never pull out the plug by tugging the power-cord.
- It is essential to connect the yellow/green conductor to earth.
- The electric connection, repairs and servicing must be carried out by a qualified employee.
- Do not switch the fixture on and off in short intervals as this would reduce the laser diode life.
- For replacement, please use fuses of same type and rating only.
- If the device has been exposed to drastic temperature fluctuation, do not switch it on immediately. The arising condensation water might damage your device. Leave the device switched off until it has reached room temperature..
- Do not shake the device. Avoid brute force when installing or operating the device.
- When choosing the installation-spot, please make sure that the device is not exposed to extreme heat, moisture or dust. There should not be any cables lying around. You endanger your own and the safety of others!
- The minimum distance between the fixture and surrounding walls must be more than 50cm.
- Always fix the fixture with an appropriate safety-rope. Fix the safety-rope at the safety-rope only.
- The ambient temperature must be between 10°C to 40°C.
- Please use the original packaging if the device is to be transported.
- Please consider that unauthorized modifications on the device are forbidden due to safety reasons!

CAUTION! Operate the device only after having familiarized with its functions. Do not permit operation by persons not qualified for operating the device. Most damages are the result of unprofessional operation

CAUTION! If this device will be operated in any way different to the one described in this manual, the product may suffer damages and the warranty void.

BEFORE OPERATION

Unpacking Instructions

⚠ CAUTION! Immediately upon receiving a fixture, carefully unpack the carton, check the contents to ensure that all parts are present, and have been received in good condition. Notify the shipper immediately and retain packing material for inspection if any parts appear damage from shipping or the package itself shows signs of mishandling. Save the package and all packing materials. In the event that a fixture must be returned to the factory, it is important that the fixture be returned in the original factory box and packing.

What is included

The carton or flight case contain following items:

NAME	QTY
Laser Light	1 PCS
KEYs (for key switch)	2PCS
Interlock Connector	1 PCS
Remote	1 PCS
Power Cord	1 PCS
USER MANUAL	1 PCS

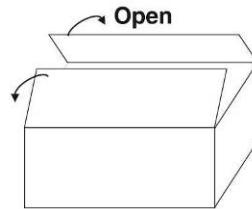

Power Supply

To determine the power requirements for a particular fixture, see the label affixed to the back plate of the fixture or refer to the fixture's specifications chart. A fixture's listed current rating is its average current draw under normal conditions. All fixtures must be powered directly off a switched circuit and cannot be run off a rheostat (variable resistor) or dimmer circuit, even if the rheostat or dimmer channel is used solely for a 0% to 100% switch. Before applying power to a fixture, check that the source voltage matches the fixture's requirement.

The unit is supplied with a power plug appropriate to its voltage and destination. Should any other connections be required they must be carried out with the following configuration.

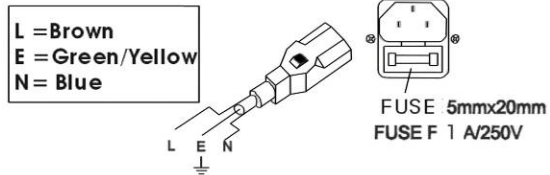

Cable(EU)	Cable(US)	Pin	International
Brown	Black	Live	L
Liht blue	White	Neutral	N
Yellow/Green	Green	Earth	

DMX-512 connection between fixtures

The fixture is equipped with 2-pin XLR sockets for DMX input and output. The sockets are wired in parallel. Only use a shielded twisted-pair cable designed for 3-pin XLR-plugs and connectors in order to connect the controller with the fixture or one fixture with another.

Occupation of the XLR-connection

DMX - output
XLR mounting-sockets (rear view):



DMX-input
XLR mounting-plugs (rear view):

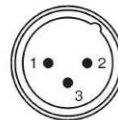

- 1 - Shield
- 2 - Signal (-)
- 3 - Signal (+)



Caution: At the laser fixture, the DMX-cable has to terminated with a terminator. Solder a 120 Ohm resistor between Signal (-) and Signal (+) into a 3-pin XLR-plug and plug it in the DMX-output of the last fixture.

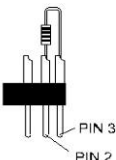

Building a serial DMX-chain

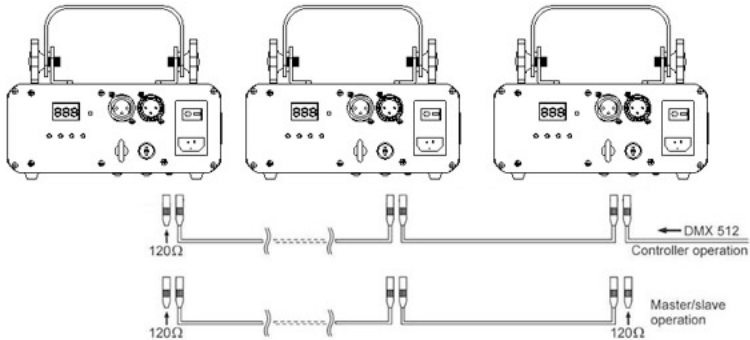

- If you are using the standard DMX-controllers, you can connect the DMX-output of the controller directly with the DMX-input of the first fixture in the DMX-chain. If you wish to connect DMX-controllers with other XLR-outputs, you need to use adapter cables.
- Connect the DMX-output of the first fixture in the DMX-chain with the DMX-input of the next fixture. Always connect output with the input of the next fixture until all fixtures are connected.
- If you use a controller with 5 pins DMX connector, you need to use a 5 to 3 pins adapter
- At last fixture, the DMX cable has to be terminated with a terminator. Solder a 120 Ohm 1/4W resistor between pin 2(DMX-) and pin 3(DMX+) into a 3 pins XLR-plug and plug it in the DMX-output of the last fixture.
- Connect the fixture together in a daisy chain by XLR plug cable from the output of the fixture to the input of the next fixture. The cable cannot be branched or split to a Y cable. DMX 512 is a very high speed signal. Inadequate or damaged cables, soldered joints or corroded connectors can easily distort the signal and shut down the system.
- The DXM output and input connectors are pass-through to maintain the DMX circuit, when power is disconnected to the unit.
- Each fixture needs to have a DMX address to receive the data from the controller. The DMX address number which could be read from rear panel of each fixture is between 000~511.
- The end of the DMX 512 chain should be terminated to reduce signal errors.

Proper Laser Set Up & Usage

This fixture has been designed to be hung. It is recommended for safety purposes, your lighting effect are properly mounted using a suitable hanging clamp and

safety cable. Items appropriate for safe and effective mounting are easily sourced from your lighting vendor.

International laser safety regulations require that lasers must be operated in the fashion illustrated below, with a minimum of 3 meters (9.8 ft) of vertical separation between the floor and the lowest laser light vertically. Additionally, 2.5 meters of horizontal separation is required between laser light and audience or other public spaces.

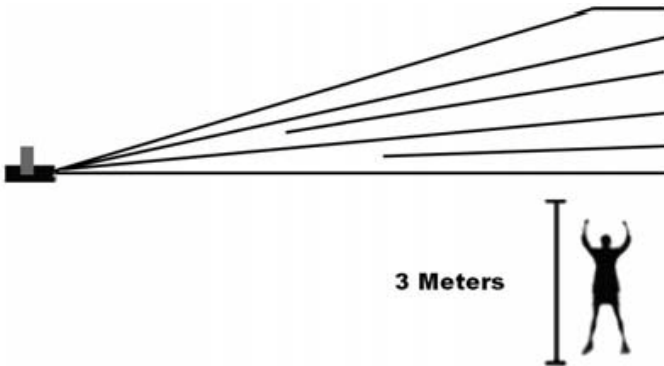

CAUTION: Use of controls, adjustments, or performance of procedures other than what is specified herein may result in hazardous radiation exposure

Rigging the Fixture

CAUTION! Please consider the respective national norms during the installation! The installation must only be carried out by an authorized employee or dealers!

- The installation of the fixture has to be built and constructed in a way that it can hold 10 times the weight for 1 hour without any harming deformation..
- The installation must always be secured with a secondary safety attachment, e.g. an appropriate catch net. This secondary safety attachment must be constructed in a way that no part of the installation can fall down if the main attachment fails.

- Make sure the area below the installation place is free from unwanted persons during rigging, de-rigging and servicing.
- The operator has to make sure that safety-relating and machine-technical installations are approved by an expert before taking into operation for the first time and after changes before taking into operation another time.
- The operator has to make sure that safety-relating and machine-technical installations are approved by a skilled person once a year.
- The fixture should be installed in the position where persons cannot reach and where persons may walk by or be seated.

CAUTION! When installing the device, make sure there is no highly inflammable material (decoration articles, etc.) in between a distance of min 0.5 meter.

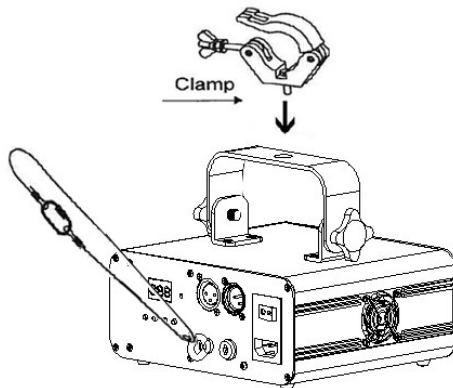

PRODUCT OVERVIEW

- This device has left out premise in absolutely perfect condition. In order to maintain this condition and to ensure safe operation, it is necessary for the user to follow the safety instructions and warning notes written in this manual.
- The manufacturer will not accept liability for any resulting damages caused by the non-observance of this manual or any unauthorized modification to the device.

Front Panel

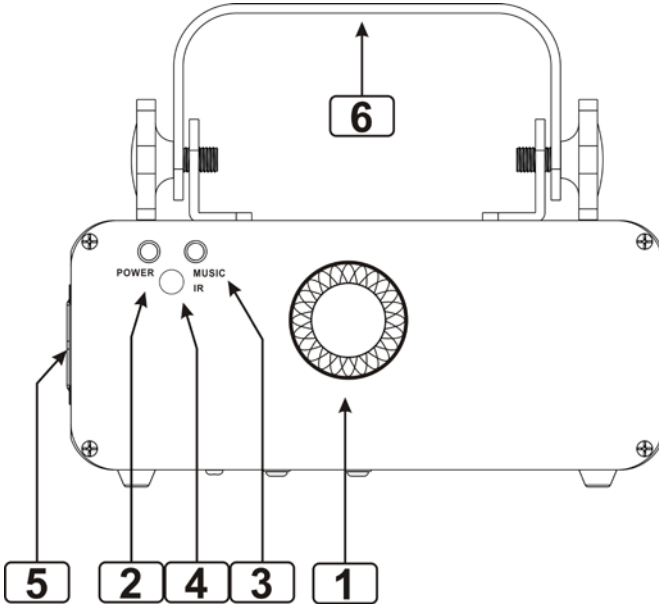

NO	NAME	FUNCTION
1	Laser output	Laser output aperture.
2	POWER	Main power indicated LED. Red is ON.
3	MUSIC/IR	Synchronize to detected music signal / IR indicator (flashing for each signal received)
4	IR	Infrared Remote Receiver
5	Cooling fan	Cooling and never cover this fan outlet
6	HANGING BRACKET	with 2 knobs on both sides to fasten the unit and a mounting hole to fix a mounting hook.

Rear Panel

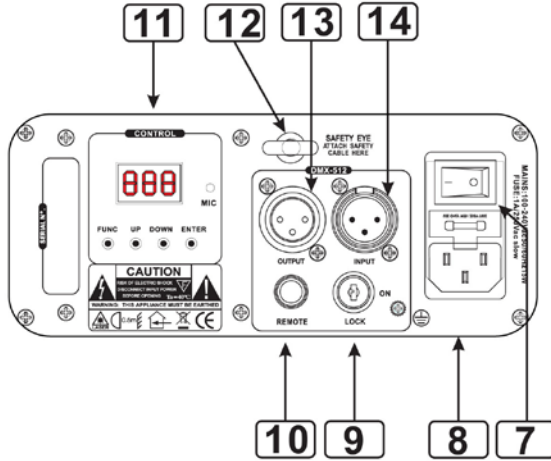

NO	NAME	FUNCTION
7	Switch	Switch on and off the power
8	Mains input	With socket and integrated fuse holder
9	Key switch	Make sure the professional person use
10	Interlock connector	For emergency laser stop
11	LED control Panel	Intelligent LED control panel of the system
12	Safety eye	Attach the safety cable
13	DMX input	3PIN Male XLR port, using for DMX
14	DMX output	3PIN Female XLR port, using for DMX

CONTROL & FUNCTION

- Regular breaks during operation are essential to maximize the life of this device as it is not designed for continual use.
- Do not switch the unit on and off in short time intervals
- Always unplug the unit when it is not used for a longer time. Or before replacing the bulb or start servicing.
- In the event of serious operation problems, stop using the fixture and contact your dealer immediately.



Attention Laser Safety Scanner Board is included in the system. The Laser light will be turned off when the scanned angle is less than 1 degree.

Operating Mode



Attention Once after every power on laser, the **VERSION** and **MANUFACTURE INFORMATION** will be shown in LCD monitor of rear panel.

When laser is powered on, LCD monitor on rear panel shows the current operating standalone mode or DMX address of DMX mode. With help of LCD control panel, is very easy to set and change the operating mode of laser. After every resetting and saved, the new mode information will be shown on LCD monitor at next power on.

FUNC

Mode Option, to choose the operating mode of laser.

ENTER

Confirmation, to confirm the laser to show the present mode at the next operation.

UP

UP/DOWN, to change operating mode, parameter or DMX address.

DOWN

OPERATION

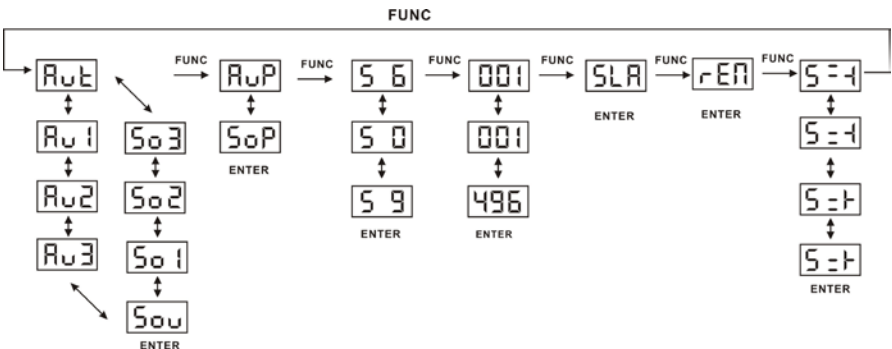

DISPALY	STAND ALONE MODE PREPROGRAM EFFECT
Aut	AUTOMATIC SHOW with RGY colors
Au1	AUTOMATIC SHOW with single RED color
Au2	AUTOMATIC SHOW with single GREEN color
Au3	AUTOMATIC SHOW with single YELLOW color
Sou	SOUND ACTIVATED SHOW with RGY colors
So1	SOUND ACTIVATED SHOW with single RED color
So2	SOUND ACTIVATED SHOW with single GREEN color
So3	SOUND ACTIVATED SHOW with single YELLOW
AUP	Auto running pattern effect show
SOP	Sound activated pattern effect show



Attention In preprogrammed standalone **MUSIC SHOW** mode, the laser beam will be blank-out in 3 seconds without **AUDIO/MIC** activated signal.

DMX MODE

- Press **FUNC** to enter **MODE** selection
- Till to LED panel shows 001
- Press **ENTER** to confirm setting

The laser is working in **DMX MODE**.
With help of **UP** and **DOWN** button, the **DMX** address could be set.

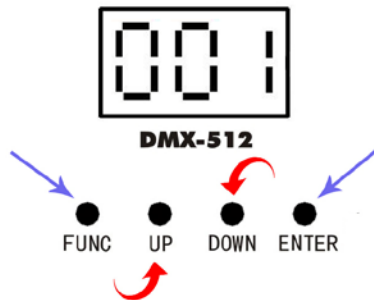

Attention In **DMX MODE**, once the **DMX** cable is connected with laser and **DMX** controller, the **DMX LED** in front panel of laser will be **ON**.

SLAVE MODE

- Press FUNC to enter MODE selection
- Till to LED panel shows SLA
- Press ENTER to confirm setting

The laser is working in SLAVE MODE. Connect MASTER laser with several SLAVE laser with DMX cable, SLAVE lasers are doing exactly the same laser show as MASTER laser. Please check chapter for DMX cable connection for referece.

REM MODE (Remote Optional)

- Press FUNC to enter MODE selection
- Till to LED panel shows REM
- Press ENTER to confirm setting

Please check **Remote Instruction** for remote control details.



Attention In any standalone mode (excepted REM and SLA), press ON/OFF  for 2 second to activate remote function.

PATTERN MIRROR REVERSE SETTING

- Press FUNC to enter MODE selection
- Till to below LED display is shown in LED panel and the laser will show pattern right side.
- Press ENTER to confirm the setting.

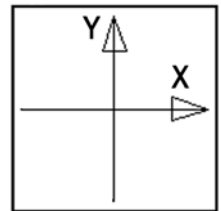
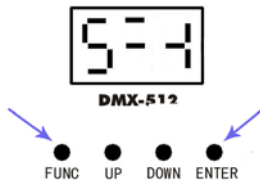

- With help of UP button, the laser scanned world in x direction could be reversed, as the graphic as below.

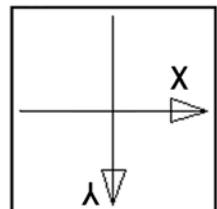
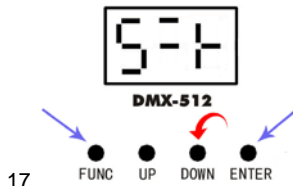

With help of DOWN button, the laser scanned world in y direction could be reversed, as the graphic as below.

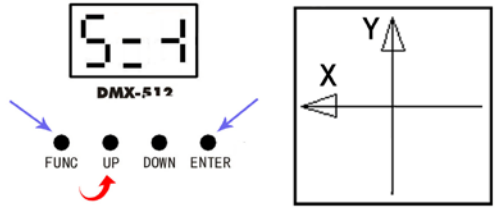



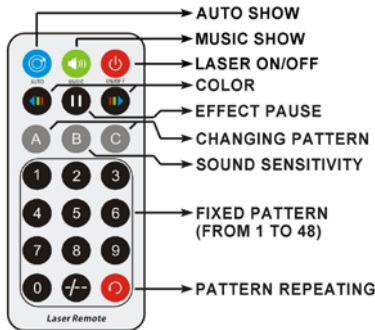

Attention Beside of LED programmed mirror reverse setting, the laser scanned world could be set by ILDA control panel.

Remote Instruction

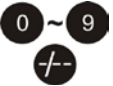

Button	Function	Description
	ON/OFF	In REM mode, to turn ON / OFF laser. In any standalone mode, excepted SLA mode, pressing 2 seconds for activate REM mode.
	AUTO	AUTO running show
	MUSIC	SOUND activated show. The blue music LED indicator is flashing when sound signal is detected.
 Sound Sensitivity		In Sound Activated Show, press MUSIC + B + “1~9” to do sensitivity setting, “9” is the most sensitive.









	COLOR CHANGING	Cycle through Programmed Color, Color 3 & Color 2, Color 1
	PATTERN CHANGING	To show and change patterns
	FIXED PATTERN	Choose favorite PATTERN from 1 to 48.
	PATTERN REPEAT	Last PATTERN and current PATTERN cycle repeating





Attention Any control or setting in remote will be saved in ram, until the system is rebooted. The system is in AUTO show in any first remote mode after reboot.

















































































DMX Channels Chart

CHANNEL	VALUE	FUNCTION
CH 1 MODE	000-020	Laser OFF ⊕
	021-040	AUT
	041-060	AU1
	061-080	AU2
	081-100	AU3
	101-120	SOU
	121-140	SO1
	141-160	SO2
	161-180	SO3
	181-200	AUP
	201-220	SOP
	221-255	DMX MODE
CH 2 GROUP	000-051	1 Group Patterns.
	052-103	2 Group Patterns
	104-055	3 Group Patterns

	156-207	4 Group Patterns	
	208-255	5 Group Patterns	
CH 3 PATTERN	000-255	Every 16 for 1 group, total 80 patterns.	
CH 4 COLOR	000-015	Original	
	016-031	Red	
	032-047	Green	
	048-063	Yellow	
	064-111	Color Rolling	
	112-159	Color Jumping	
	160-207	Color Moving	
	208-255	Strobing	
CH 5 CLIPING	000	Full pattern without clipping	
	001-127	0%~99% fixed pattern clipped	
	128-255	Clipping Speed	
CH 6 ZOOMING	000-127	100%-5% fixed pattern zoomed	
	128-169	Zooming IN	
	170-209	Zooming OUT	
	210-255	Alternately Zooming	
CH7 ZOOM SPEED	000-255	Fast to Slow	
CH 8 Y AXIS ROLLING	000-127	0 -359 degree fixed Y axis rolled	
	128-191	Clockwise rolling	
	192-255	Anticlockwise rolling	
CH 9 ROLL SPEED	0-255	Fast to Slow	
CH 10 X AXIS ROLLING	000-127	0 -359 degree fixed X axis rolled	
	128-191	Clockwise rolling	
	192-255	Anticlockwise rolling	
CH 11 ROLL SPEED	0-255	Fast to Slow	
CH 12 Z AXIS ROLLING	000-127	0 -359 degree fixed Z axis rolled	
	128-191	Clockwise rolling	

	192-255	Anticlockwise rolling
CH 13ROLL SPEED	0-255	Fast to Slow 
CH 14 X AXIS MOVING	000-127	128 different fixed position on X axis
	128-191	Clockwise moving
	192-255	Anticlockwise moving
CH 15MOVE SPEED	0-255	Fast to Slow 
CH 16 X AXIS MOVING	000-127	128 different fixed position on Y axis
	128-191	Clockwise moving
	192-255	Anticlockwise moving
CH 17MOVE SPEED	0-255	Fast to Slow

PATTERN LIST

DMX	1	2	3	4	5
000-015					
016-031					
032-047					
048-063					
064-079					
080-095					
096-111					
112-127					
128-143					
144-159					
160-175					
176-191					
192-207					
208-223					
224-239					
240-255					

SPECIFICTAIONS

Mains Input:	AC100~240V, 50/60Hz
Fuse:	250V /1A Slow Blow (20mm Glass)
Total Power:	15W
X/Y Axis Beam Angle:	±20°
Music Control:	Audio / Sound Activated
Laser Power:	40mW 532nm Green CW 100mW 650nm Red CW
Laser Classification:	Class 3B
Laser Safety Standard:	EN60825-1 2007
Condition Temperature:	10~40°C
DMX Connections:	3 pins XLR Male/Female
DMX Channels	Max 17 channels
Measurement:	See picture below
N Weight:	1.5Kg

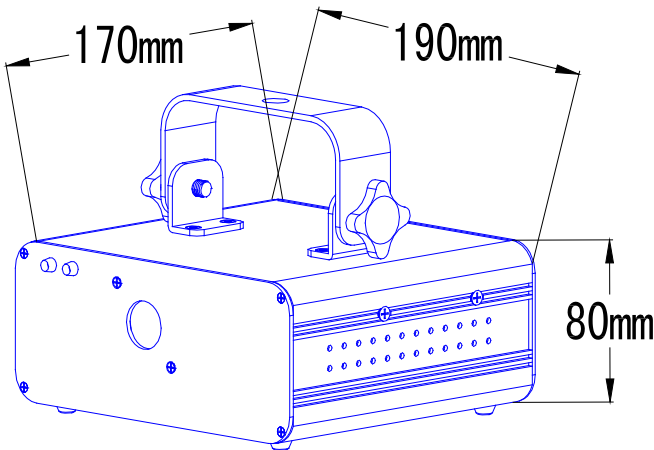

Every information is subject to change without prior notice.

The availability of particular products may vary by region. Please check with the dealer.



D A CH

Wichtige Sicherheitshinweise

Dieses Gerät ist der Laserklasse 3B zugeordnet.



WARNUNG Die zugängliche Laserstrahlung ist gefährlich für das Auge, häufig auch für die Haut. Das direkte Blicken in den Strahl bei Lasern der Klasse 3B ist gefährlich. Ein Strahlbündel kann unter Umständen sicher über einen diffusen Reflektor betrachtet werden.

- Für den Betrieb eines Lasers der Klasse 3B muss ein Laserschutzbeauftragter vom Unternehmer schriftlich bestellt werden und während des Betriebs anwesend sein (Berufsgenossenschaftliche Vorschrift BGV B2).
Laserschutzbeauftragte müssen ausreichende Fachkunde besitzen!
- Für Laser der Klasse 3B ist eine Abnahme erforderlich!

GB

Important Safety Notes

This unit is classified as a class 3B laser product.



WARNING The accessible laser radiation is hazardous to the eye, also frequently to the skin. It is hazardous to look directly into the beam of class 3B lasers. It may be possible to view a beam safely via a diffusing reflector.

- When using a class 3B laser, the employer has to appoint a laser safety officer in writing who has to be present during operation (BGV B2 = German Accident Prevention & Insurance Association regulation B2).
Laser safety officers must have the requisite qualification!
- An approval is required for class 3B lasers!

F B CH

Conseils importants de sécurité

Cet appareil est classé comme produit répondant à la classe laser 3B.



AVERTISSEMENT Le rayonnement laser accessible est dangereux pour les yeux, souvent aussi pour la peau. Regarder directement dans le faisceau de lasers de classe 3B est dangereux. Eventuellement, il n'est pas dangereux de regarder un faisceau via un réflecteur diffuseur.

- Pour le fonctionnement d'un laser de classe 3B, un responsable pour la sécurité laser doit être désigné par écrit par l'employeur, il doit être présent pendant le fonctionnement du produit (réglementation allemande de la prévention des accidents et association d'assurances BGV B2).
Le responsable de la sécurité laser doit avoir les qualifications requises!
- Pour des lasers de classe 3B, une autorisation est nécessaire !

I

Importanti avvertenze di sicurezza

Questo apparecchio è assegnato alla classe laser 3B.



AVVERTIMENTO La radiazione accessibile del laser è pericolosa per l'occhio, spesso anche per la pelle. Guardare direttamente nel raggio è pericoloso nel caso dei laser della classe 3B. Un fascio di raggi può essere guardato eventualmente con sicurezza per mezzo di un riflettore diffuso.

- Per l'impiego di un laser della classe 3B, l'imprenditore deve nominare per iscritto un tecnico di sicurezza laser che deve essere presente durante l'uso (norma della Cassa previdenza contro gli infortuni sul lavoro BGV B2).
I tecnici di sicurezza laser devono possedere delle conoscenze sufficienti della materia!
- Per i laser della classe 3B è obbligatorio un collaudo!

NL B

Belangrijke veiligheidsinstructies

Dit apparaat is ingedeeld in de laserklasse 3B.



WAARSCHUWING De toegankelijke laserstraling is heel gevaarlijk voor het oog en vaak ook voor de huid. Rechtstreeks in de straal kijken van klasse 3B-lasers is gevaarlijk. Een stralenbundel kan eventueel veilig via een diffuse reflector worden bekeken.

- Voor het gebruik van laserapparatuur klasse 3B moet er een laserveiligheidsverantwoordelijke schriftelijk worden aangesteld door de onderneming, en moet hij of zij tijdens het bedrijf aanwezig zijn (voorschrift BGV B2 van de Duitse beroepsvereniging).
Laserveiligheidsverantwoordelijken moeten over voldoende deskundigheid beschikken!
- Voor laserapparatuur klasse 3B is een keuring vereist!

Laserstrahlung

Nicht dem Strahl aussetzen

Laser Klasse 3B

Nach DIN EN 60825-1:2007

Laser Radiation

Avoid exposure to the beam

Class 3B laser

According to DIN EN 60825-1:2007

Rayonnement laser

Eviter toute exposition au faisceau

Laser Classe 3B

Selon DIN EN 60825-1:2007

Radiazione laser

Non esporsi al raggio

Laser classe 3B

Secondo DIN EN 60825-1:2007

Laserstraling

Vermijd blootstelling aan de straal

Laserklasse 3B

Conform DIN EN 60825-1:2007

**E**

Notas de Seguridad Importantes

Este producto está clasificado como láser de clase 3B.

ADVERTENCIA

La radiación láser a la que se puede acceder es peligrosa para el ojo humano y a menudo también para la piel. Es peligroso mirar directamente hacia el haz de un láser de la clase 3B. Existe la posibilidad de ver un haz con seguridad mediante un reflector de difusión.

- Cuando se utiliza un láser de la clase 3B, el dueño tiene que designar por escrito un encargado para la seguridad del láser que deberá estar presente siempre durante el funcionamiento (BGV B2 = Regulación B2 de la Asociación de Aseguradoras y Prevención de Accidentes Alemana). ¡Los encargados de la seguridad láser deben tener la cualificación necesaria!
- ¡Se necesita una autorización para un láser de la clase 3B!

PL

Środki bezpieczeństwa

Urządzenie należy do 3B klasy laserów.

UWAGA

Wiązka laserowa jest bardzo szkodliwa dla ludzkiego oka, a czasem również skóry. Patrzenie bezpośrednio na wiązkę lasera klasy 3B może być niebezpieczne. W razie konieczności wykorzystaj reflektory rozpraszające.

- Podczas wykorzystywania laserów klasy 3B, należy zapoznać się z obowiązującymi dyrektywami (w Niemczech: BGV B2 = German Accident Prevention & Insurance Association regulation B2). Osoby obsługujące urządzenia laserowe muszą posiadać odpowiednie kwalifikacje!
- Stosowanie laserów klasy 3B wymaga zezwolenia!

DK

Vigtige sikkerhedsanvisninger

Denne enhed er klassificeret som en class 3B laser.

ADVARSEL

Laserstråling er skadelig for øjne og hud. Det er skadeligt, at kigge direkte ind i laserstrålen, på en class 3B laser. Stråler er ikke skadelige, hvis der er monteret en reflekterende diffusor.

- Når en class 3B laser benyttes, skal en sikkerhedsansvarlig person skriftligt være udpeget og denne skal altid være tilstede under brugen af laseren. (BGV B2). Den sikkerhedsansvarlige person skal have den nødvendige uddannelse!
- En class 3B laser kræver særlig godkendelse fra myndighederne!

S

Viktig säkerhetsinformation

Denna enhet är klassad som en class 3B laser produkt.

VARNING

Den åtkomliga laserstrålningen är farligt för ögat, och även ofta för huden. Det är farligt att titta direkt in i strålen av class 3B laser. Det kan vara möjligt att titta på en laserstråle på ett säkert sätt via en diffunderande reflektor.

- När du använder en class 3B laser, ska arbetsgivaren skriftligen utse en tjänsteman för lasersäkerhet som måste vara närvarande under drift (BGV B2 = German Accident Prevention & Insurance Association regulation B2). Laserskyddsombud ska ha erforderlig kompetens!
- Ett godkännande krävs för class 3B laser!

FIN

Turvallisuudesta

Tuote on luokiteltu 3B-luokan laserlaitteeksi.

HUOMIO

Lasersäteilyllä altistuminen on haitallista silmille ja usein toistettuna myös iholle. On haitallista katsoa suoraan 3B-luokan lasersäteeseen. Saattaa olla mahdollista katsoa sädettä turvallisesti tummennetun lasin kautta.

- 3B-luokan laserin turvallisesta käytöstä vastaava henkilö on nimettävä kirjallisesti, ja hänen on oltava paikalla laitetta käytettäessä (vakuutusyhtiöiden vastuuvakuutusäännös BGV B2). Laserin käytöstä vastaavalla henkilöllä on oltava tarvittava pätevyys!
- 3B-luokan lasereille vaaditaan hyväksyntä!

Radiación Láser

Evite la exposición al haz

Láser de la clase 3B

Según la DIN EN 60825-1:2007

Promieniowanie laserowe

Unikać kontaktu z promieniami

Klasa lasera: 3B

Zgodnie z DIN EN 60825-1:2007

Laserstråling

Undgå kontakt med laserstrålerne

Class 3B laser

DIN EN 60825-1:2007

Laserstrålning

Undvik exponering från laserstrålen

Klass 3B laser

Enligt DIN EN 60825-1:2007

Lasersäteily

Vältä altistumista säteelle

3B-luokan laser

DIN EN 60825-1:2007 mukaan